

366036 PC Ring & Cover 2 Piece Cover

TOP VIEW

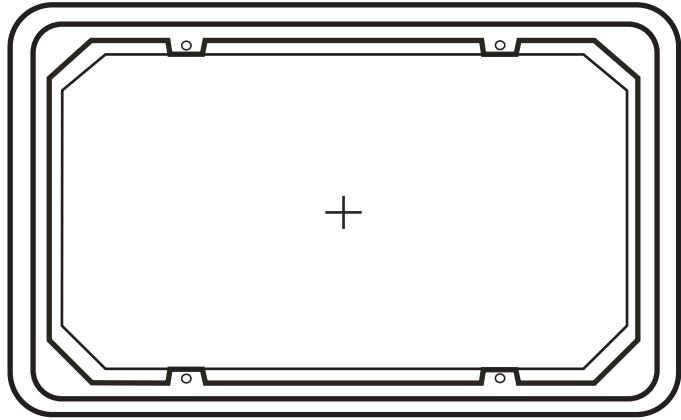

COVER VIEW

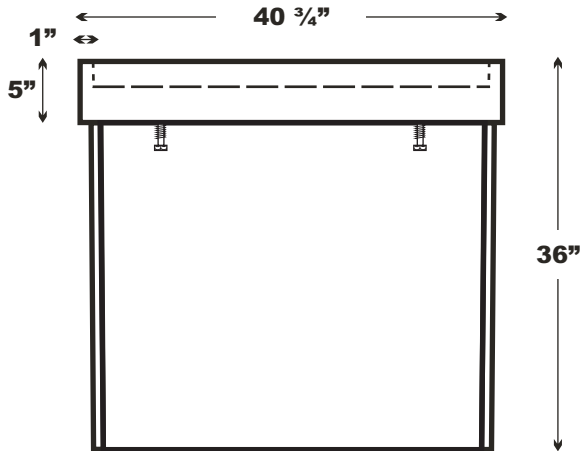
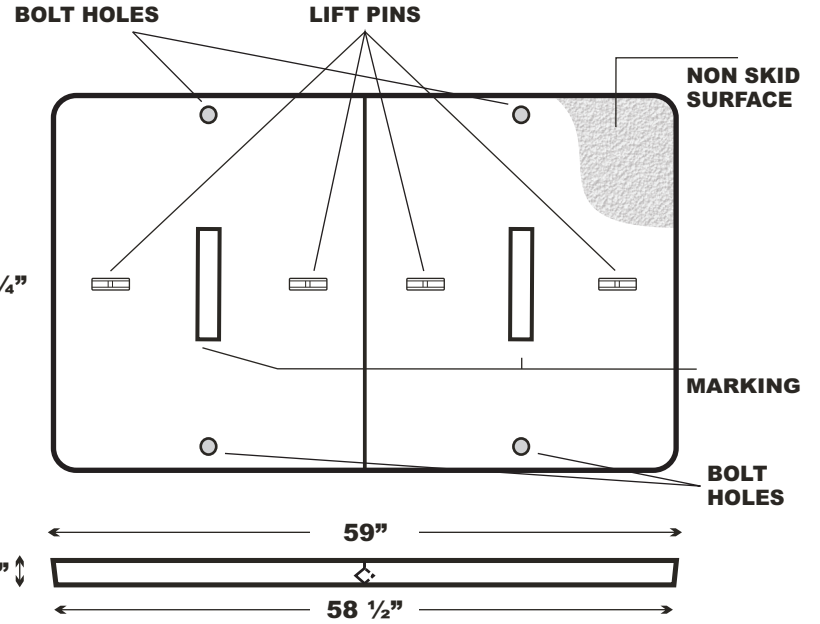

END VIEW

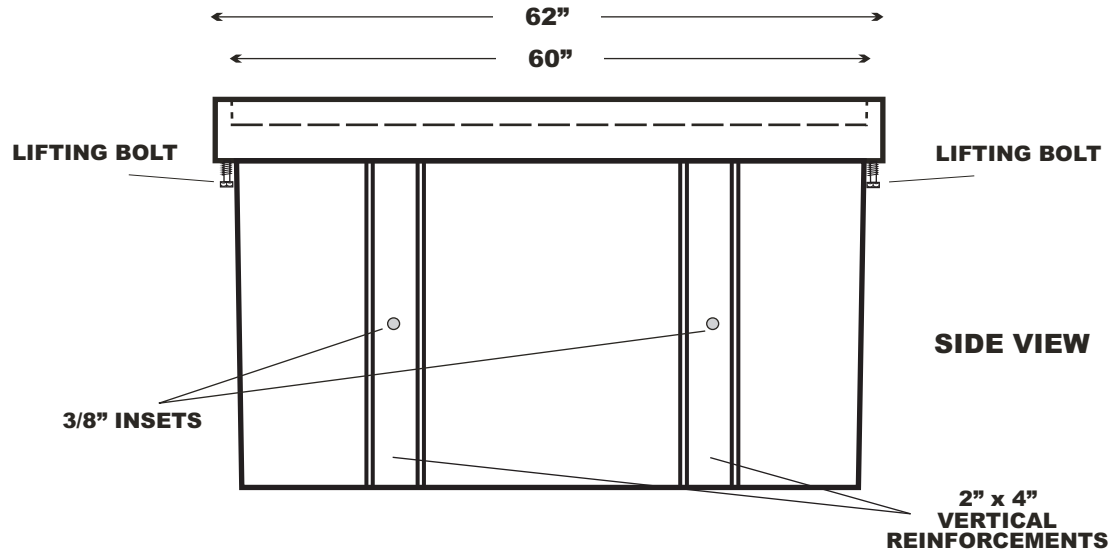

SIDE VIEW

Part No. 366036 PC		
BODY: POLYMER CONCRETE		
COVER: POLYMER CONCRETE		
Weight 940 lbs.	Tolerance +/- 1/8"	Weight Load 20k
Date July 18 2010	File 306036 RFRP PC	



Martin Enterprises
"Your Underground Enclosure Experts"

WWW.MARTINFRP.COM

7231 Boulder Ave. #262
Highland, CA 92346
Tel: 951.928.8713
Fax: 951.928.4623

This product design is the sole property of Martin Enterprises. This design is NOT to be altered unless written permission is allowed by Martin Enterprises only.