

304830 Polymer Concrete Box & Cover

TOP VIEW

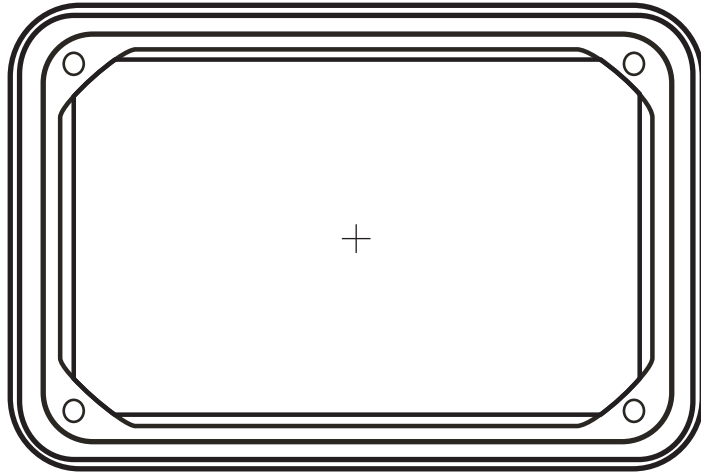

COVER VIEW

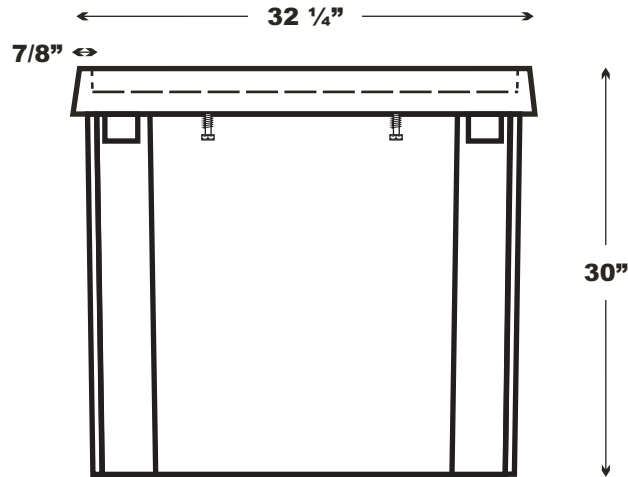
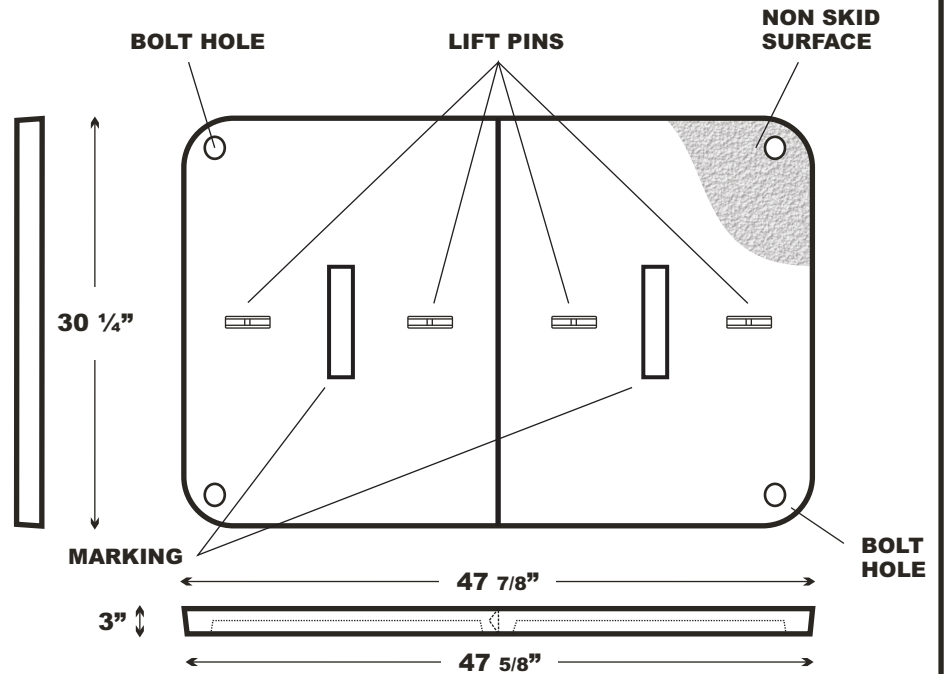

END VIEW

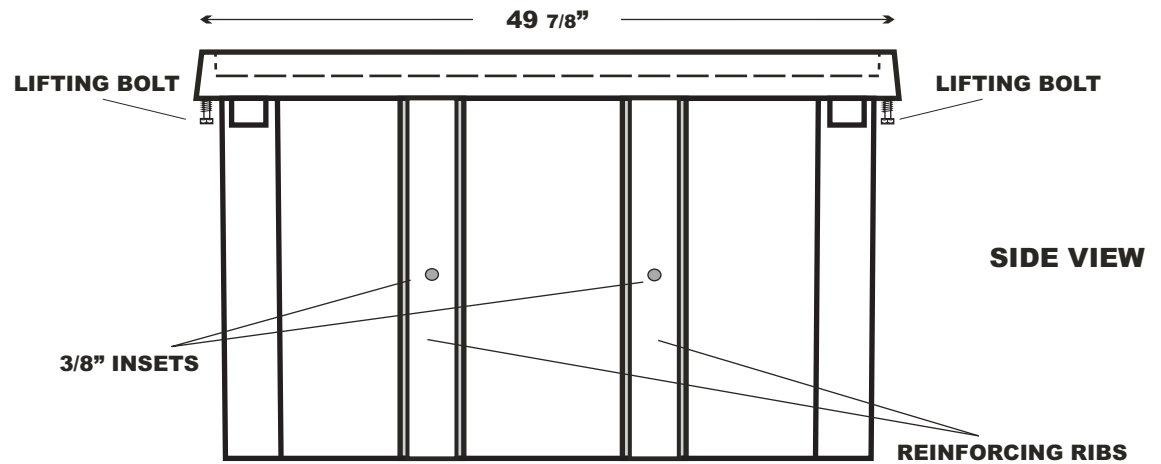

SIDE VIEW

MATERIAL: POLYMER CONCRETE
STANDARD COLOR: GRAY
OTHER COLORS AVAILABLE

Part No. 304830 PC		
BODY: POLYMER CONCRETE		
COVER: POLYMER CONCRETE		
Weight 620 lbs.	Tolerance +/- 1/8"	Weight Load 20k
Date July 8 2009	File 304830 PC	



Martin Enterprises
 "Your Underground Enclosure Experts"

WWW.MARTINFRP.COM

7231 Boulder Ave. #262
 Highland, CA 92346
 Tel. 951.928.8713
 Fax: 951.928.4623

This product design is the sole property of Martin Enterprises. This design is NOT to be altered unless written permission is allowed by Martin Enterprises only.